

Introduction to Neural Networks
U. Minn. Psy 5038

Daniel Kersten

Lecture 2

Getting started with *Mathematica*

Review this section in Lecture 1

The Neuron - overview of structure

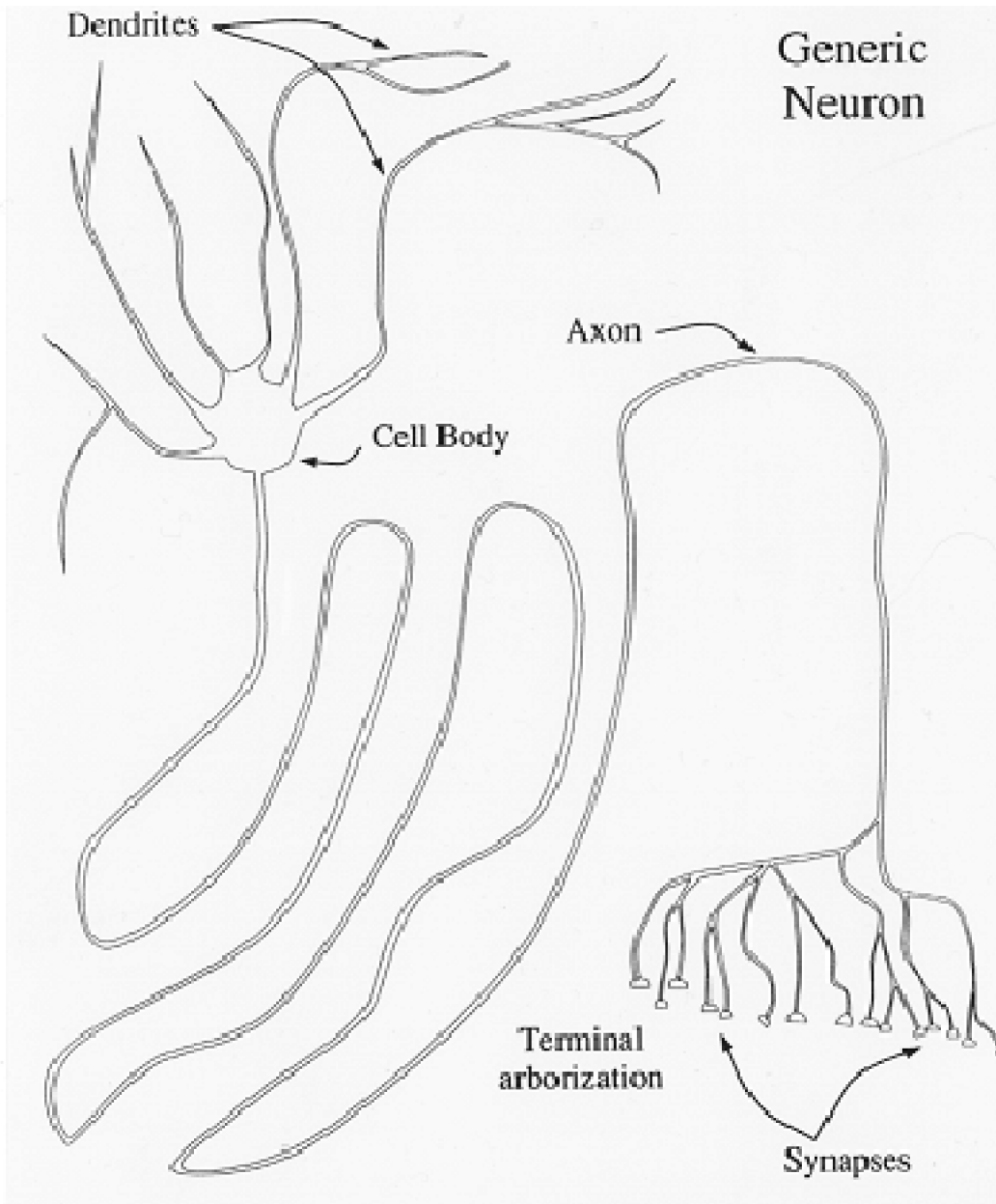

From Anderson (1995)

Basic Structure

Information flow: dendrites -> (soma -> axon hillock) -> axon -> terminal buds

■ Dendrites

The information receiving end of a neuron is a tree-like structure consisting of "dendrites" with special processes or connection sites called synapses. Much computational power is thought to reside in the strength of connections, and in the dendritic tree itself. In this course, we will primarily examine the computational properties of groups of simple neurons, rather than aggregates of dendrites in a single neuron.

Dendrites play the role of wires that convey information through changes in voltage. But they behave rather differently than copper wires. These neural processes are tubes of ionized cytoplasm sitting in a bath of ionized fluid whose ionic composition is not that much different from "seawater". The inside of these tubes during resting state sits at about minus 60-70 millivolts relative to the outside of the cell. The tubes are on the order of microns in diameter, (but other processes, such as the axons discussed below, can reach half a millimeter or so). And for further comparison, the membranes making up the tubes are on the order of 50 Angstroms (50×10^{-10} meters) thick.

Signal transmission is limited by high electrical resistance of the axoplasm, and high electrical capacitance of the neural membrane. Information transmission consequences of these properties are:

- *the voltage potential changes have a short range of influence*, with the amplitude decreasing rapidly as one moves away from the synaptic source.

- *the signals travel relatively slowly*.

We'll take a quantitative look at these facts shortly.

■ Soma (or cell body)

- Integrates dendritic signals--*spatial integration* from sites along a dendrite and between dendrites

- The storage of electrical charge across the membrane, and the chemical nature of synaptic transmission leads to *temporal integration* of signals. This observation together with spatial integration of signals from the dendritic tree arriving at the axon hillock will lead to our basic model of the neuron.

■ Axon hillock and axon

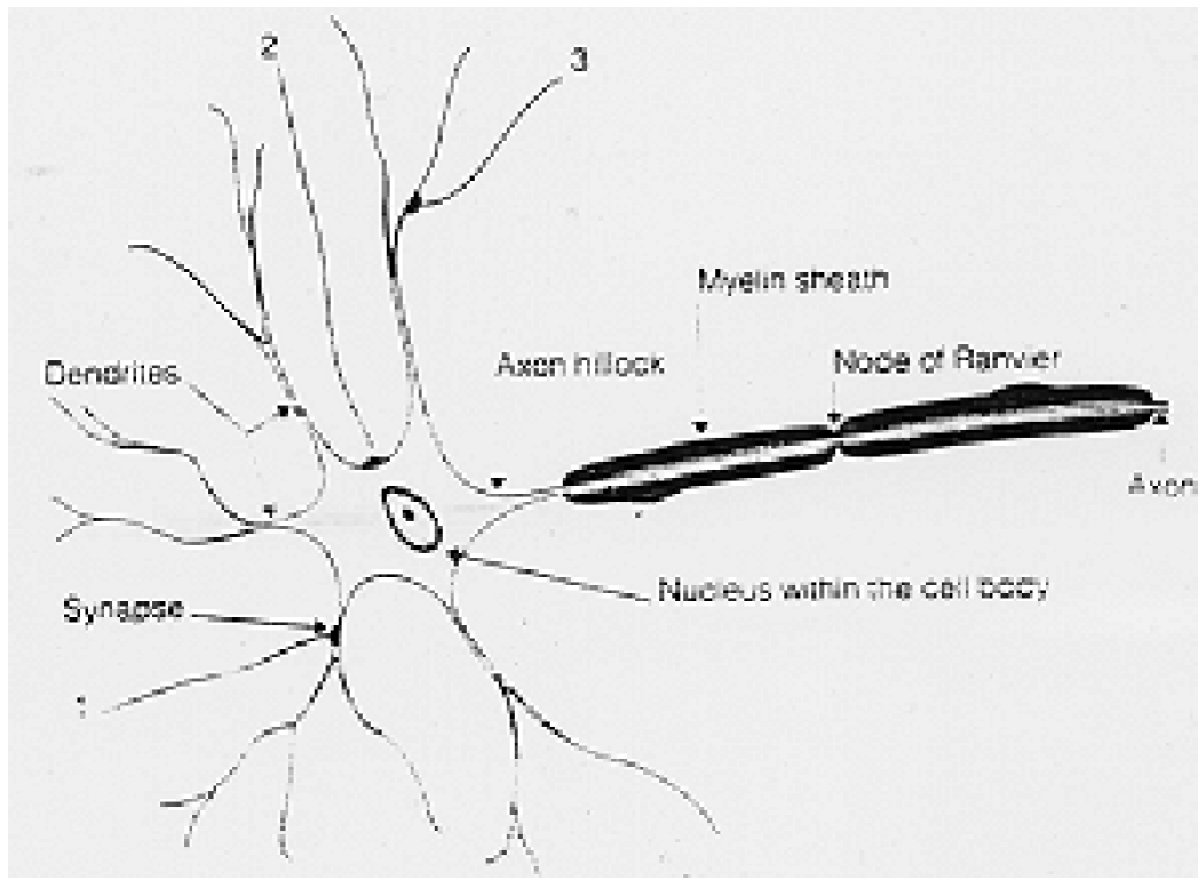

How can the range and speed be increased?

As seen in the above figures, certain neurons are equipped with a specialized process called an axon that serves to "digitize" the data into all-or-none responses (voltage changes) called *action potentials* or *spikes*. This digitization occurs at the axon hillock near the cell body. There is *passive* or electrotonic conduction along the dendrites up to the axon hillock at which point, if there is a sufficient potential change to reach threshold, an *active* process of depolarization kicks in leading to a spike in membrane voltage.

Depolarization means the voltage potential difference across the membrane *decreases*; *hyperpolarization* can also occur, where the voltage difference *increases*.

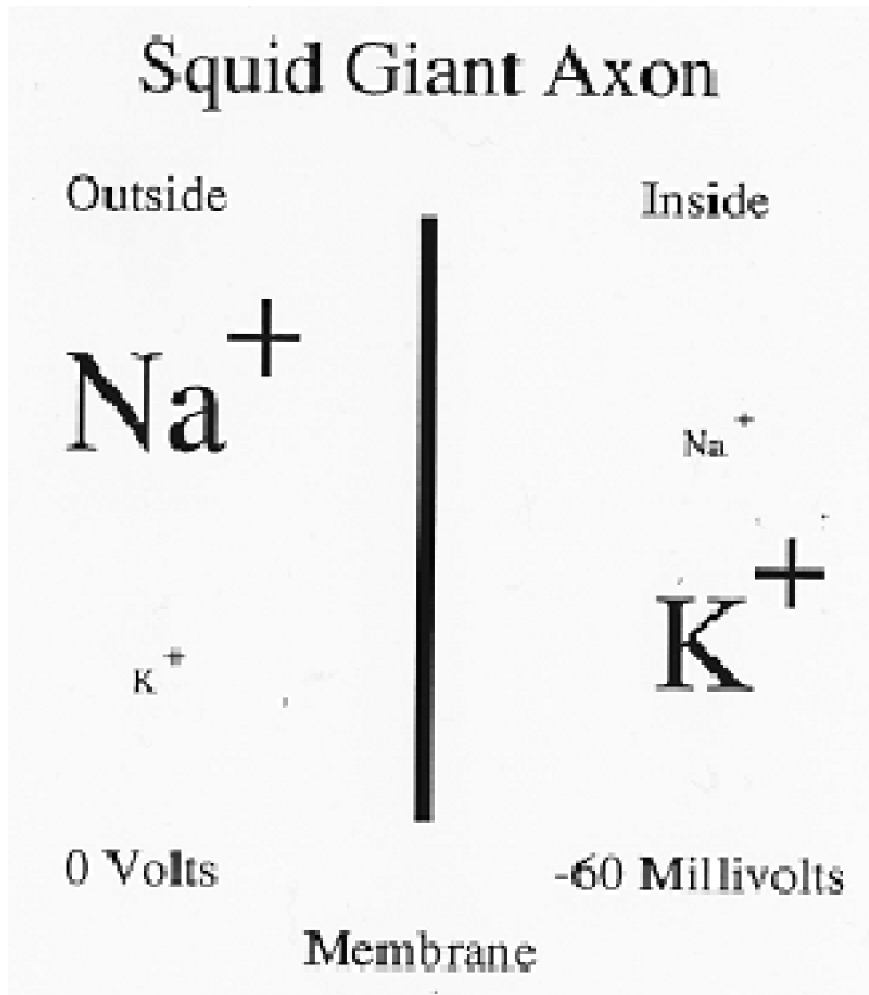

The action potential signals are carried by rapid (1 msec) voltage depolarizations going from -70 to +40 mV via Na^+ influx, and K^+ outflow through the membrane. From the axon hillock on, a myelin sheath serves to lower the capacitance, increase resistance, and speed up conduction. However it interferes with the regenerative processes that preserve the all-or-none response. At periodic points (Nodes of Ranvier) the myelin sheath is interrupted where high extracellular concentrations of Na^+ ions exist with sodium gates. When a small depolarization arrives, this decreases membrane conductance allowing an increased depolarizing influx of Na^+ , regenerating the spike.

■ Terminal arborization and terminal buds

Neurons with axons end in a terminal arborization. The terminal buds make synaptic contacts with the dendrites of subsequent neurons, and we have the beginnings of a neural network. Synaptic contacts can either be electrical or chemical, but more about these later.

Basic electrophysiology

Passive properties

Above we noted that the potential is maintained by ionic imbalance (excess Na^+ outside, and K^+ inside). The balance between ionic concentration and electric field forces is determined by the Nernst equation (e.g. see Anderson for a derivation).

We noted two problems: passing a signal over a long distance and with sufficient speed--BIG problem for an organism that has to transmit signals fast over a few feet.

Let's take a more quantitative look at these problems that arise from the passive electrical properties of neuronal "electronics".

Model the passive electrical properties as a function of **time** :

- Across a small portion of the membrane modeled by an "RC circuit" where R stands for resistance, and C for capacitance.

We'll see shortly that there is a temporal delay in voltage response characterized by time constant τ or rise time.

RC-circuits are "low pass temporal filters", i.e. favor signals with low temporal frequencies.

and **space**:

- If we imagine cascading a series of RC-circuits, each connected by additional resistances, we have a discrete model of a section of neural membrane. This kind of model is good for computer simulation. But a continuous model can be solved exactly.

A continuous model over time and short lengths is called the "Cable equation" (Anderson, pages 25-32), made famous by Lord Kelvin (Sir William Thomson, 1824-1907) in the context of submarine telegraph cables (Ireland to Newfoundland in 1858.)

We'll see below how the cable equation predicts an exponential drop-off of voltage with distance for constant current. The length constant λ (distance to the $1/e$ drop-off point or 63% drop) is on the order of millimeters.

By solving the cable equation governing the voltage change over distance and time, we can get a quantitative idea of how voltage drops with distance, and how voltage changes with time--the basic message being that *change is not instantaneous*.

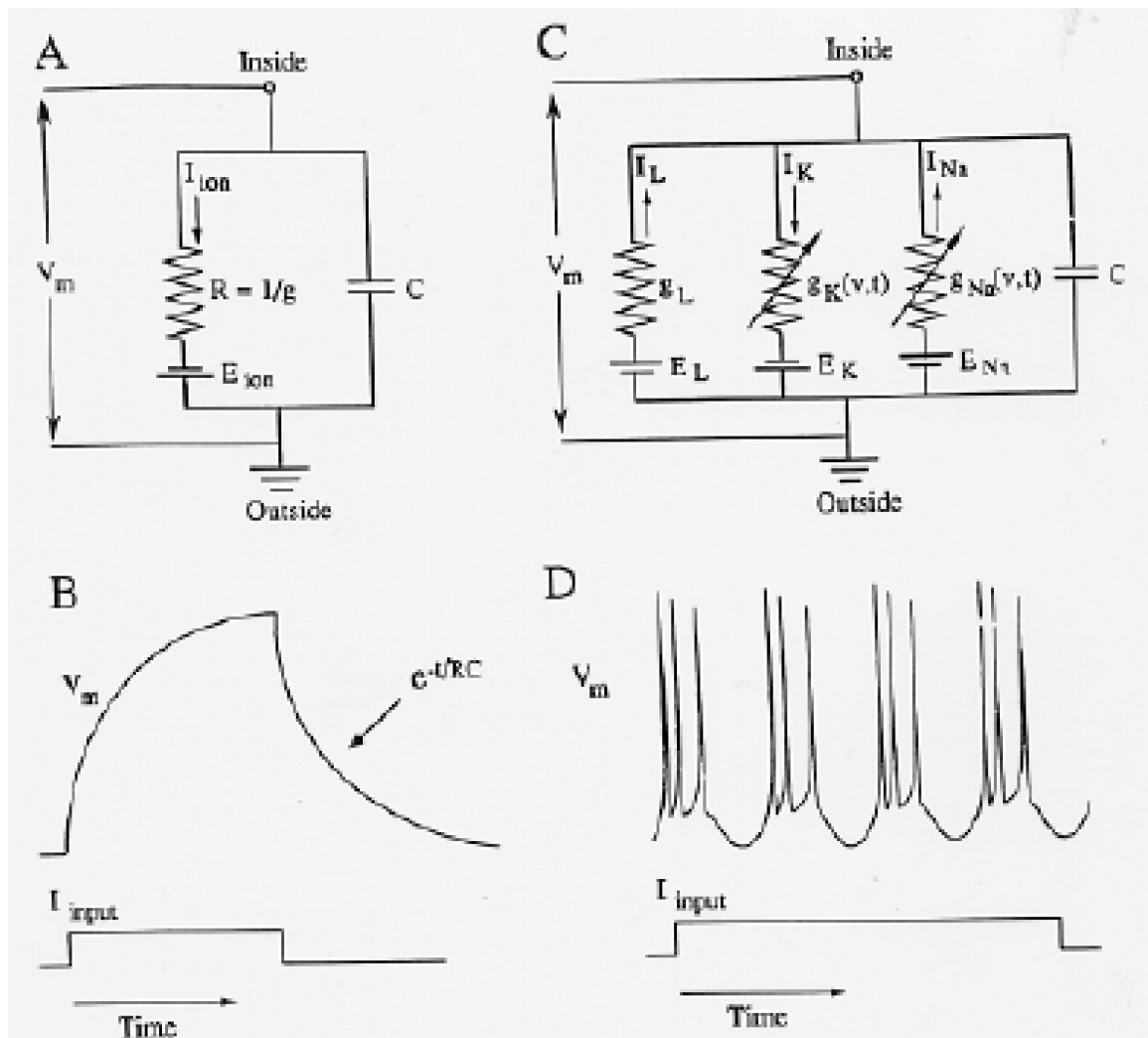

From Segev (1992). A. illustrates an RC-circuit at a single point of *passive* membrane. B is the temporal response to a step current input. C illustrates additional variable conductance components that model the electrical processes of spike generation (panel D)—the *active* properties. To model the active properties, one needs a more complicated set of differential equations: the Hodgkin-Huxley equations. (See Claude Meunier and Idan Segev, 2002 for an overview and critique). In the next lecture, we'll use *Mathematica* to derive a simplification of the Hodgkin-Huxley equations.

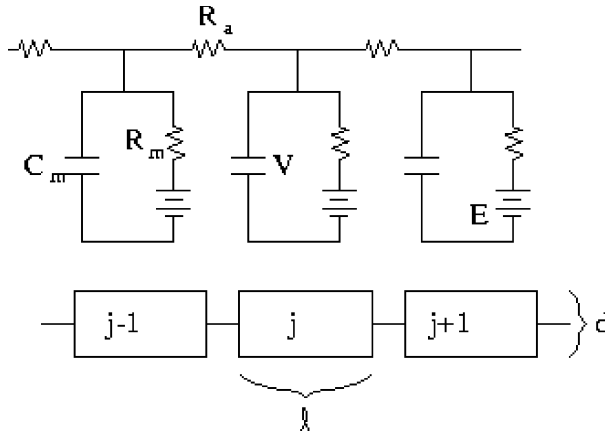

From Ermentrout (<http://www.cnbc.cmu.edu/~bard/passive2/passive2.html>).

■ Solutions of the cable equation

The cable equation is given by:

$$V = \lambda^2 \frac{\partial^2 V}{\partial x^2} - \tau \frac{\partial V}{\partial t}$$

where $V = V(x,t)$ is the voltage across the membrane as a function of distance x along the membrane and time t .

Let's look separately at the space and time properties.

Space.

In a later Notebook, we'll see how to use *Mathematica* to find solutions to equations, including differential equations for passive and active membranes. For now, let's take the steady-state solution for a fixed voltage, V_0 , at a specific place, say $x = 0$, and see how the voltage drops away from zero. Steady-state means that the voltage is no longer changing with time, or in another words that $\frac{\partial V}{\partial t} = 0$.

$$V = \lambda^2 \frac{\partial^2 V}{\partial x^2}$$

The solution of this equation (which you can verify by differentiating twice, see exercise below) is a standard result. The voltage drops exponentially. Lambda is the "space constant", which for an axon would be about 3 to 5 mm.

$$V(x) = V_0 e^{-x/\lambda}$$

```
In[1]:= V0 = 1; lambda = 2; (*Space constant*)
V[x_] := V0 Exp[-Abs[x]/lambda];
```

```
In[3]:= Plot[V[x], {x, -4, 4}, PlotRange -> {0, 1}]
```

```
Out[3]=
```

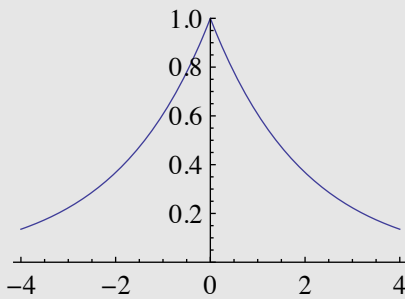

The space constant $\lambda = \sqrt{(d/4) R_m R_a}$, where d is the diameter, and R_m and R_a are the membrane and axial resistances, respectively.

Use *Mathematica's* derivative function `D[]` on `V[x]` re-defined below to verify the solution. Differentiate `V(x)` twice with respect to `x`, where `V(x)` is re-defined over positive `x` values (it is simpler to treat positive and negative `x` separately):

```
In[4]:= Clear[V];
V[x_] := V0 Exp[-x/λ];
```

Time.

Now let's see how membrane voltage changes with time at a single location by plotting the time solution to the cable equation. We'll assume no space variation, so we set $\frac{\partial^2 V}{\partial x^2} = 0$. Standard integration techniques can be used to solve this

simplified cable equation: $V[t] = -\tau \frac{\partial V}{\partial t}$.

$$V(t) = 1 - e^{-t/\tau}$$

Let's assume some initial conditions.

Suppose a 1 volt step is applied (through some resistance to generate a step current change) across the neuron membrane at time $t=1$. How does voltage change with time at a fixed point x ? It doesn't immediately change to 1 volt, but grows gradually. A typical time constant τ is on the order of 1 or 2 msec.

```

In[8]:=  $\tau = 1;$ 
 $V[t_] := 1 - e^{-\frac{t}{\tau}};$ 
g1 = Plot[V[t - 1], {t, 1, 6}, PlotRange → {-1, 1.5},
  AxesOrigin → {-1, -.5}, PlotStyle → RGBColor[1, 0, 0]];

g2 = Plot[UnitStep[t - 1], {t, -.5, 6}, PlotRange → {-1, 1.5},
  AxesOrigin → {-1, -.5},
  PlotStyle → {RGBColor[1, 0, 0], RGBColor[0, 0, 1]};
Show[{g1, g2}]

```

Out[12]=

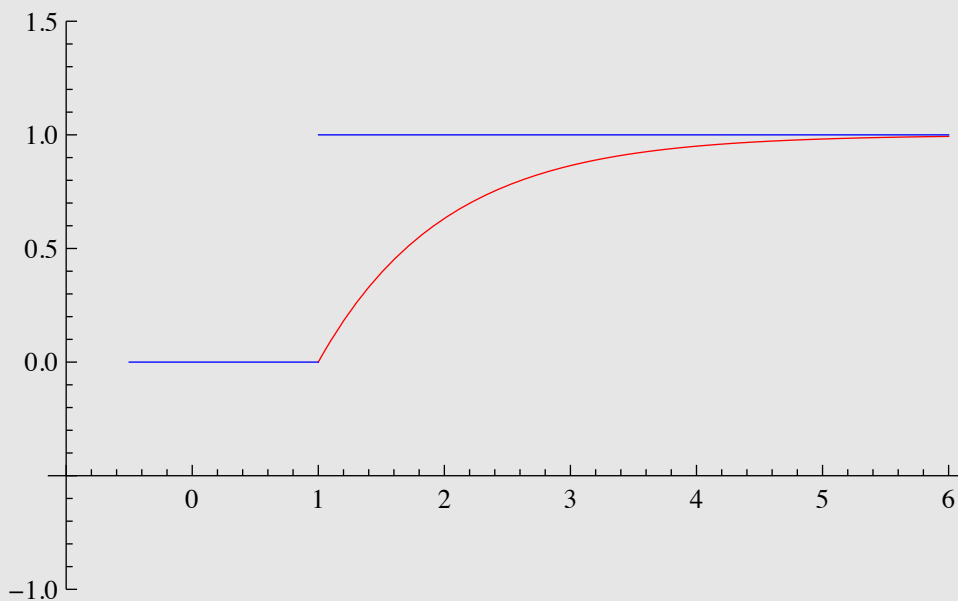

(UnitStep is a built-in *Mathematica* function. You could define your own as: `myUnitStepstep[x_] := If[x<0,0,1];`)

In summary, with passive properties there is a rapid (exponential) drop-off in signal strength with distance; further, the response to an abrupt input takes time to develop.

Active (non-linear) properties

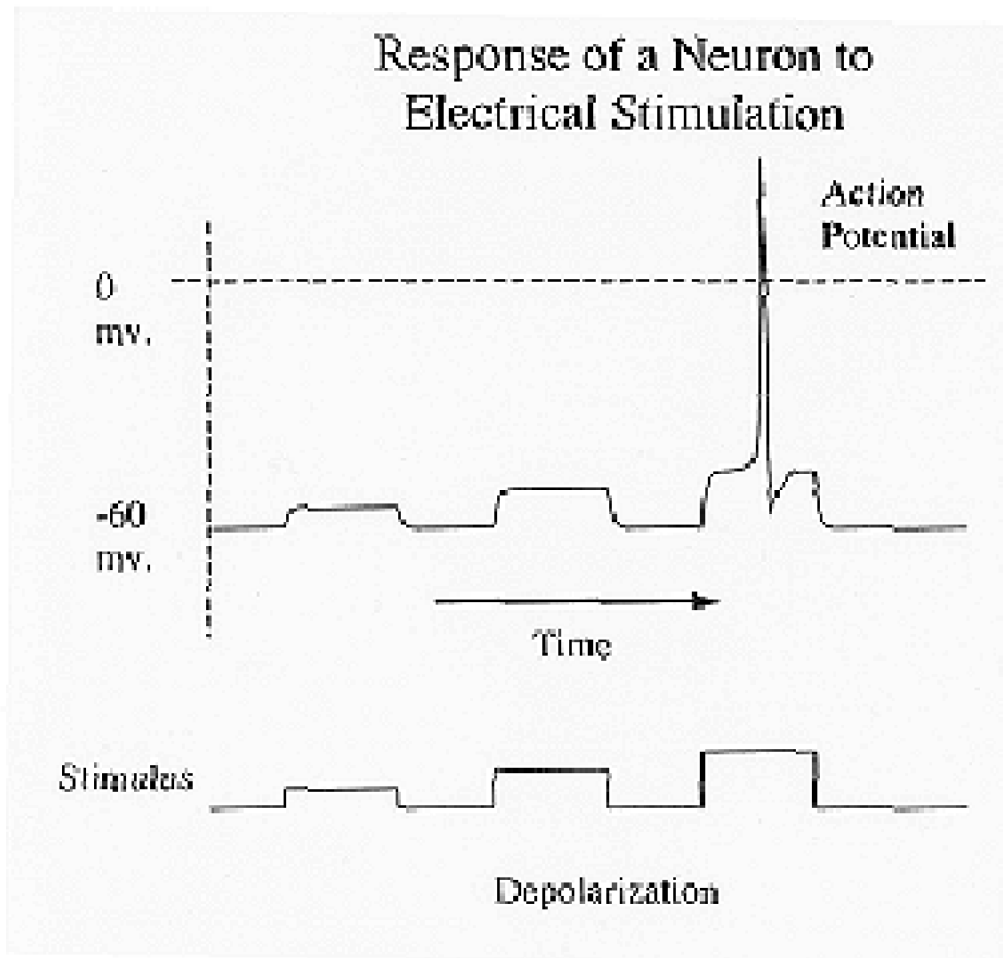

Action potentials, spike trains are nature's solution to the problem of fast long distance signalling.

Action potential generation as "toilet flush model" - small push of the handle and a little leak, but reach a threshold, and the whole thing goes.

To quantitatively model these voltage changes, one needs to add extra terms to the RC circuit (panels C and D above). We'll see a *Mathematica* implementation later, and also see Meunier and Segev (2002).

Space properties

What is the neuron's solution to the rapid decline in voltage signal over distance due to passive properties?

Action potential at one location provides the depolarization stimulus at a nearby spatial location, travels like a lit fuse down the membrane. Unlike the passive voltage change, the size of the action potential voltage stays the same.

Time properties

And how about the speed problem?

myelin sheath (insulation increases resistance and reduces current leakage)

Nodes of Ranvier, action potentials jump from node to node, up to **30x faster**.

Refractory period: absolute, and relative

Absolute refractory period is a brief time (~1 msec) right after the depolarization where no strength of input current would be sufficient for another spike. The ion pumps need time to restore some of the ionic imbalance.

Relative refractory period- threshold gradually lowers with time. One can elicit a spike, but it requires a stronger input signal. This is one of the factors that leads to the idea of *frequency coding*. (Later in the course, we'll spend much time on the question of the "neural code"--i.e. what information is represented by the pattern of action potentials in a neural network). A constant step input leads to a series of spikes of a particular frequency (e.g. if the absolute refractory period is 1 msec, we'd expect a maximum spike frequency of 1000 spikes/second), but usually much lower (e.g. 20 spikes/second). To get a faster rate, the input voltage would have to be increased. This leads to the idea of the neuron as a "voltage-to-frequency" converter. But it gets a little more complicated because neurons often show "adaptation" and the firing rate declines for a fixed step input. More on that later.

You can verify the refractory properties yourself with the *Mathematica* model of the solutions to the Hodgkin-Huxley equations.

Synaptic Integration

Terminal buds do not make "direct" contact with dendrites. There is a gap between the two neurons, with information resulting in a voltage change being passed either electrically, or via chemicals called neurotransmitters.

Some definitions:

pre-synaptic potential --across the membrane of the terminal of the "transmitting" neuron

post-synaptic potential -- across the membrane of the dendrite of the "receiving" neuron

Two types: **excitatory** (make the cell more likely to fire) and **inhibitory** (less likely to fire) post-synaptic potentials

These post-synaptic potentials have a relatively long duration - even a fast excitatory post-synaptic potential or **EPSP** is 1 to 2 msec rise time and 3 to 5 msec decay (action potential 1-2 msec)

synaptic delay - about 500 micro-seconds.

Interaction of synaptic potentials

Imagine 1000's of synaptic inputs to a single neuron. How do they interact? This question is fundamental to understanding neural network modeling.

When the graded potentials arrive at the axon hillock, do they sum

algebraically? I.e. is the cumulative effect at the hillock an algebraic sum? If so, this greatly simplifies the modeling, because

of the rich set of tools and understanding we have of "linear systems".

Our generic connectionist model introduced later will assume linear algebraic summation, and only introduce non-linearities as needed.

Linear summation properties are sometimes but not always seen (see Koch and Segev, 2000). The figure shows empirical results. The top and bottom traces are inputs, the middle trace is the result of combining these two inputs. The dotted trace is the algebraic sum prediction. Panel A shows simple algebraic summation, but Panel B shows measurements in which the integrated signal is not a simple sum.

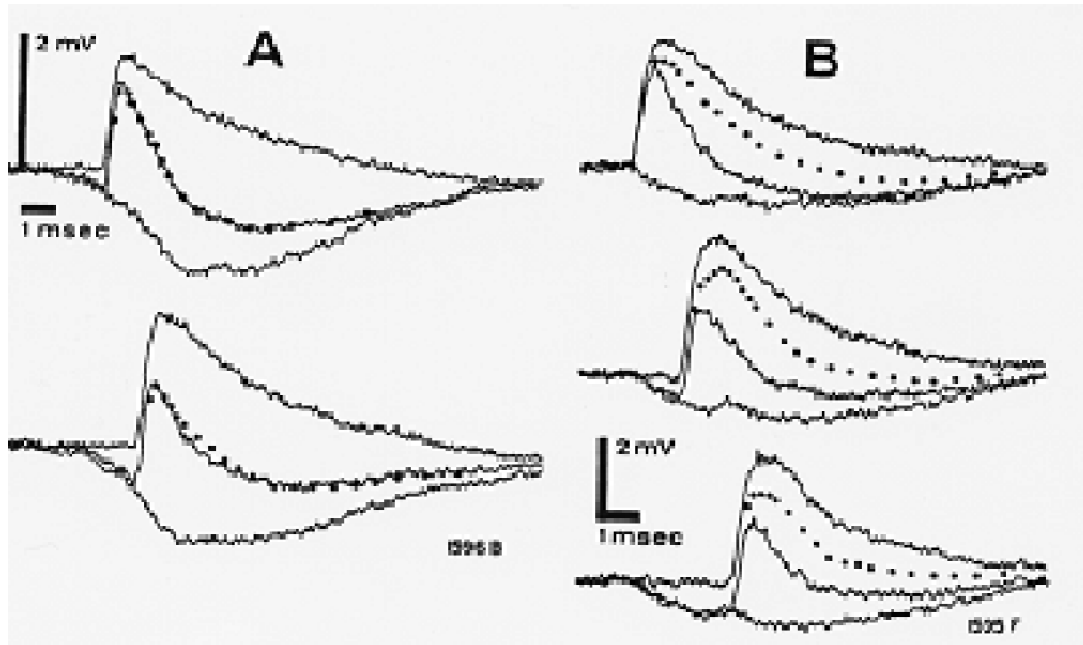

Interaction of **inhibitory postsynaptic potentials (IPSP)** and **excitatory postsynaptic potentials (EPSP)** can be linear (left column, A) or non-linear (right column, B). From Rall (1967). Dotted line shows linear prediction.

Qualitative summary of slow potential neuron model

Let's summarize the essential qualitative features of signal integration and transmission of a neuron with what is called the "slow potential model".

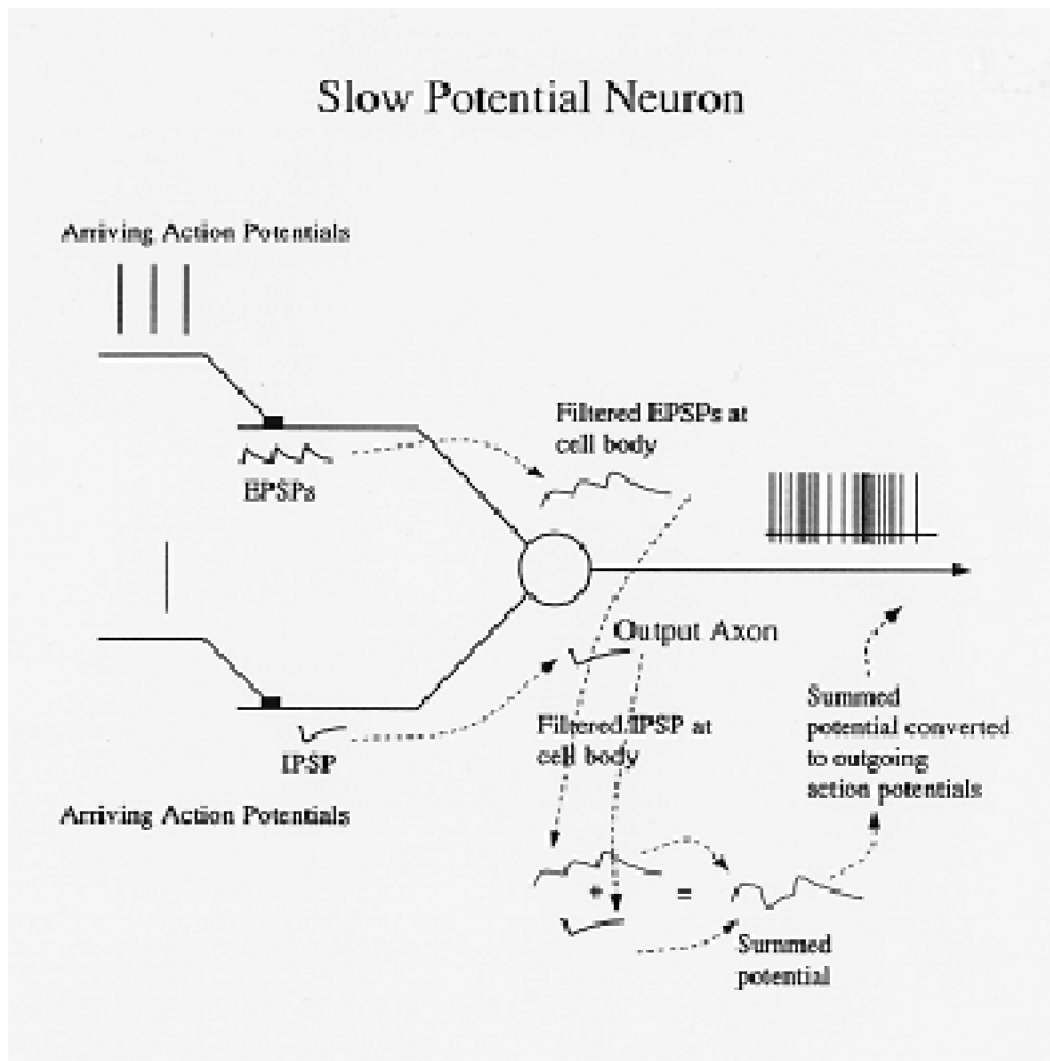

Slow potential at axon hillock waxes and wanes (because of low-pass temporal characteristics and the spatial distribution of the inputs) depending on the number of active inputs, whether they are excitatory or inhibitory, and their arrival times. (Temporal "low-pass" filtering simply means that fast changes don't get through.)

The slow integrated voltage potential now and then exceeds threshold producing an axon potential.

Further, if the slow potential goes above threshold, frequency of firing is related to size of slow potential. We'll develop a quantitative description of this, called the "integrate and fire" model, in the next Lecture.

Caveat: Not all signal transmission in neural computation is done through action potentials. For example, of the 6 types of cells in the retina of your eye, essentially 1 type, the ganglion cells, uses action potentials, the others communicate via slow potentials.

Spike generation isn't a strictly deterministic process. There is "**noise**" or **random fluctuation**. This means one isn't guaranteed of getting exactly the same spike discharge for identical inputs. This is because:

- ion channels open and close probabilistically

- neurotransmitter is released in discrete packages, adding uncertainty in the signal to the next neural in the

signalling pathway

sensory receptors can produce spontaneous signals (not to mention that the physical causes of sensory stimulation have noise too).

One way to model the noisiness of a neuron's discharge is to treat spike train frequency as roughly like a Poisson process (better--an interval Gamma distribution) whose mean is modulated by the already noisy slow potential. (See PoissonDistribution[.])

■ For a quick overview using a different style of presentation, see:

<http://www.youtube.com/watch?v=eZundDVPIYw>

Next time

Brief history of neural models

Various classes of models

Develop the "Integrate and fire" model

References

Ermentrout, G. Bard <http://www.cnb.cmu.edu/~bard/passive2/passive2.html>

Hodgkin, A. L., & Huxley, A. F. (1952). A quantitative description of membrane current and its application to conduction and excitation in nerve. *J. Physiol. (Lond.)*, 117, 500-544.

Koch, C. (1998). Biophysics of Computation : Information Processing in Single Neurons . Oxford: Oxford Univ. Press.

Koch, C., & Segev, I. (1998). Methods in Neuronal Modeling : From Ions to Networks. Cambridge, MA: MIT Press, 671 pages.

Koch, C., & Segev, I. (2000). The role of single neurons in information processing. *Nat Neurosci*, 3 Suppl, 1171-1177.

Meunier, C., & Segev, I. (2002). Playing the devil's advocate: is the Hodgkin-Huxley model useful? *Trends Neurosci*, 25(11), 558-563.

Segev, I. (1992). Single neurone models: oversimple, complex and reduced. Trends in Neuroscience, 15(11), 414-421.

© 1998, 2001, 2003, 2005, 2007, 2009 Daniel Kersten, Computational Vision Lab, Department of Psychology, University of Minnesota.